

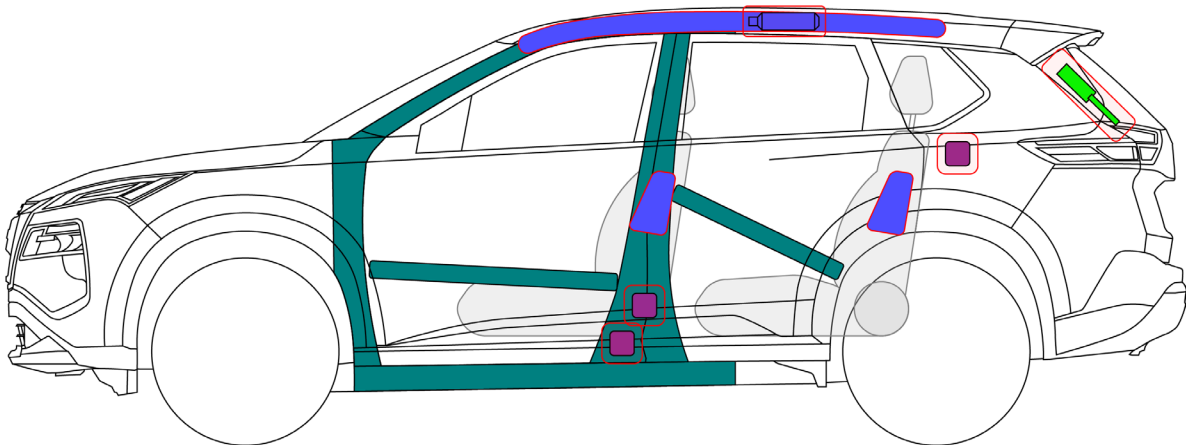

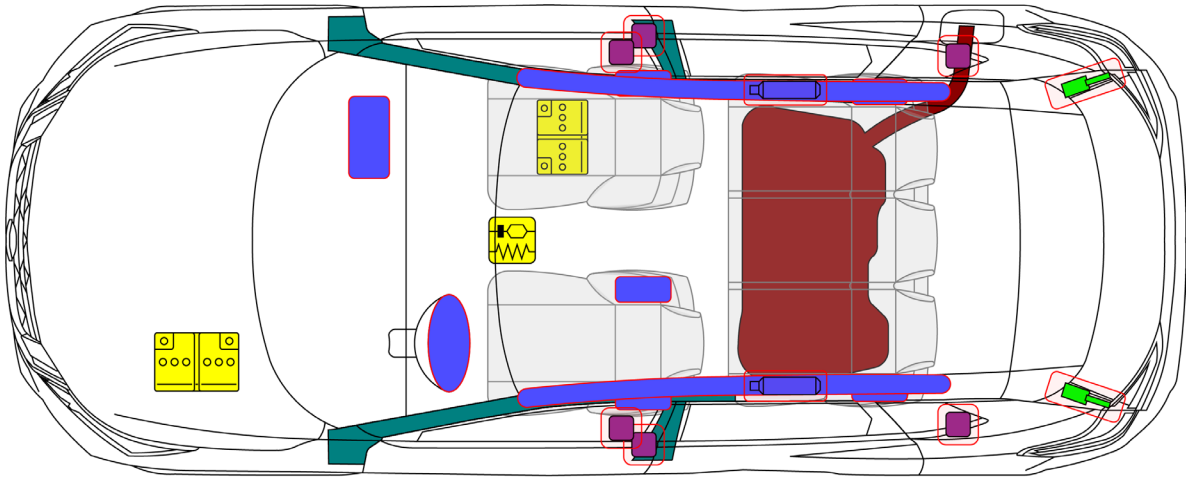







Nissan X-Trail

TYPE: T33, 5-door SUV
(2022 -)



 Turvatyyny	 Varastoitu kaasutäyttöjärjestelmä	 Turvavyönkristin	 SRS-hallintayksikkö	 Akku, matala jännite
 Kaasujousi / esijännitetty jousi	 Korkean lujuuden alue	 Polttoainesäiliön sisältö bensiini/etanolii		

1. Ajoneuvon tunnistaminen/ identifiointi



2. Ajoneuvon sammuttaminen / stabilointi

Varmista, ettei ajoneuvo voi liikkua:

1. Lohkopyörät
2. Kytke seisontajarru päälle
3. Paina kerran P (park)-painiketta ja valitse P (park) asema

Nostokohdat:



Sopivat nostokohdat

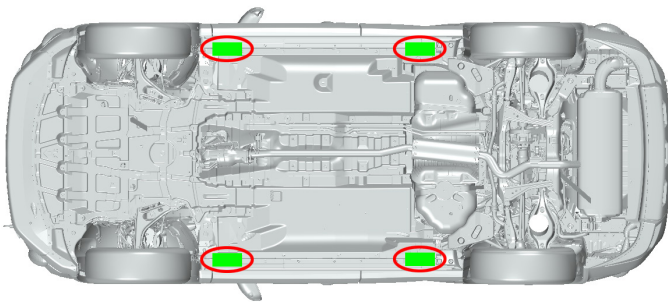

3. Ajoneuvon vaarattomaksi tekeminen

1. Sammuta moottori painamalla Start/Stop-painiketta



Mikäli mahdollista, poista sähköavain ja säilytä vähintään 5 metrin (16 jalan) etäisyys ajoneuvoon

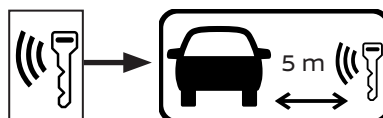

Pääsy moottoritilaan

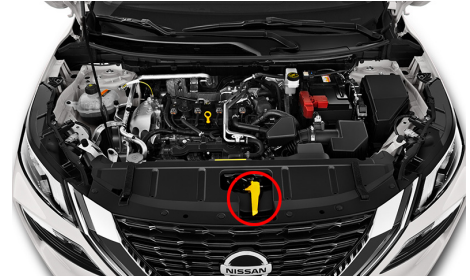

2. Irrota 12 V:n akku

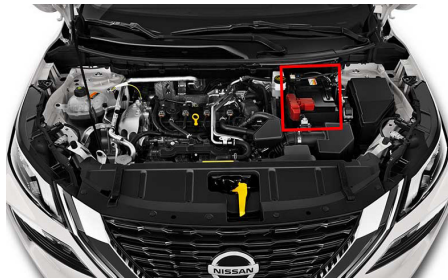
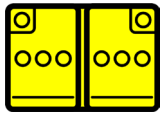

4. Ajoneuvon sisällä olevien pelastaminen

Rungossa ja ovesa luja teräs

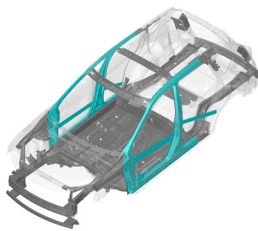

Ohjaustangon säätäminen



Istuimen säätö

Sähköinen



Käsin



Lasityypit:

- A. Laminoitu lasi
- B. Karkaistu lasi



5. Ajoneuvon käyttövoima, nesteet, kiinteät aineet

	12V	
	R-1234yf 1005 g	
	55L	
	12V Li-ion	

8. Hinaaminen / Kuljetus / Varastointi

Sijainti hinaussilmukka

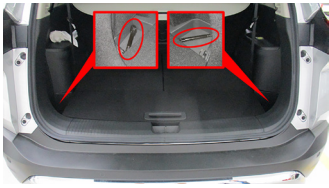

Etukoukun sijainti



Takakoukun sijainti



Hinaaminen

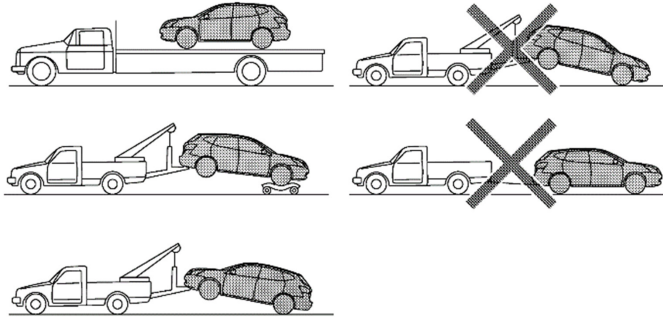

10. Merkkien selitykset

	Poista älyavain		Syttyvä
	Varoitus		Vaarallinen ihmisten terveydelle
	Varoitus; matala lämpötila		Räjähävä
	Ilmastointilaite		Syövyttävät aineet
	Ajoneuvo nestemäisen ryhmän 1 polttoaineella		Konepelti